

# Field Operations Guide for In-Situ Burning of On-Water Oil Spills

API TECHNICAL REPORT 1252  
FIRST EDITION, JULY 2015



AMERICAN PETROLEUM INSTITUTE

## **Special Notes**

API publications necessarily address problems of a general nature. With respect to particular circumstances, local, state, and federal laws and regulations should be reviewed.

Neither API nor any of API's employees, subcontractors, consultants, committees, or other assignees make any warranty or representation, either express or implied, with respect to the accuracy, completeness, or usefulness of the information contained herein, or assume any liability or responsibility for any use, or the results of such use, of any information or process disclosed in this publication. Neither API nor any of API's employees, subcontractors, consultants, or other assignees represent that use of this publication would not infringe upon privately owned rights.

API publications may be used by anyone desiring to do so. Every effort has been made by the Institute to assure the accuracy and reliability of the data contained in them; however, the Institute makes no representation, warranty, or guarantee in connection with this publication and hereby expressly disclaims any liability or responsibility for loss or damage resulting from its use or for the violation of any authorities having jurisdiction with which this publication may conflict.

API publications are published to facilitate the broad availability of proven, sound engineering and operating practices. These publications are not intended to obviate the need for applying sound engineering judgment regarding when and where these publications should be utilized. The formulation and publication of API publications is not intended in any way to inhibit anyone from using any other practices.

Any manufacturer marking equipment or materials in conformance with the marking requirements of an API standard is solely responsible for complying with all the applicable requirements of that standard. API does not represent, warrant, or guarantee that such products do in fact conform to the applicable API standard.

All rights reserved. No part of this work may be reproduced, translated, stored in a retrieval system, or transmitted by any means, electronic, mechanical, photocopying, recording, or otherwise, without prior written permission from the publisher. Contact the Publisher, API Publishing Services, 1220 L Street, NW, Washington, DC 20005.

## Foreword

American Petroleum Institute (API) publications necessarily address problems of a general nature, with respect to particular circumstances, local, state, and federal laws and regulations should be reviewed.

API is not undertaking to meet the duties of employers, manufacturers, or suppliers to warn and properly train and equip their employees, and others exposed, concerning health and safety risks and precautions, nor undertaking their obligations under local, state, or federal laws.

Nothing contained in any API publication is to be construed as granting any right, by implication or otherwise, for the manufacture, sale or use of any method, apparatus, or product covered by letters patent. Neither should anything contained in the publication be construed as insuring anyone against liability for infringement of letters patent.

API publications may be used by anyone desiring to do so. Every effort has been made by the Institute to assure the accuracy and reliability of the data contained in them; however, the Institute makes no representation, warranty, or guarantee in connection with this publication and hereby expressly disclaims any liability or responsibility for loss or damage resulting from its use or for the violation of any federal, state, or municipal regulation with which this publication may conflict.



# Contents

<b>Purpose of this Field Operations Guide</b> .....	<b>vii</b>
Priorities for Oil Spill Response .....	vii
Safety.....	vii
Intended Audience .....	vii
<b>How to Use This Field Guide</b> .....	<b>vii</b>
<b>Introduction</b> .....	<b>1</b>
Specific In-Situ Burning Considerations .....	1
ISB Decision-Making Components .....	4
<b>ISB Field Operations Checklists</b> .....	<b>5</b>
General Precautions and Preferred Conditions.....	5
Prerequisites.....	6
Logistical Considerations.....	7
Location Considerations .....	9
Monitoring, Notifications, and Documentation .....	11
ISB Plan Components of an Incident Action Plan .....	12
<b>Habitat-Specific ISB Information</b> .....	<b>18</b>
Open Sea and Large Lakes.....	18
Shallow and Near Shore Areas .....	18
Cold Climate Considerations .....	19
Ice Conditions on Water .....	20
<b>Appendix A Appropriateness of ISB</b> .....	<b>21</b>
<b>Appendix B Personnel Safety</b> .....	<b>25</b>
<b>Appendix C Weather and Smoke Management</b> .....	<b>27</b>
<b>Appendix D Oil Containment &amp; Fire Safety</b> .....	<b>31</b>
<b>Appendix E Ignition of ISB</b> .....	<b>40</b>
<b>Appendix F Efficiency and Burn Volume Estimation</b> .....	<b>44</b>
<b>Appendix G Air Quality Monitoring</b> .....	<b>47</b>
<b>Appendix H Unburned Oil &amp; Post-Burn Residue Recovery</b> ....	<b>51</b>
<b>Appendix I Incident Command for ISB</b> .....	<b>53</b>
<b>Glossary</b> .....	<b>57</b>
<b>References</b> .....	<b>61</b>



## **Purpose of this Field Operations Guide**

This is a field operations guide. It is not an educational or decision-making tool. This Guide contains a set of operational checklists, tools, and references to assist in the conduct of in-situ burning (ISB) of spilled oil in the marine environment.

### **Priorities for Oil Spill Response**

- People—safety of response personnel and the public.
- Environment—prevention of long-term health and welfare effects.
- Assets—minimizing damage to vessels, structures and equipment.

### **Safety**

Responder safety and health must never be compromised for tactical considerations. Likewise ISB should be conducted to minimize smoke/particulate safety and health impacts to responders, the general public, users of sea lanes, etc.

### **Intended Audience**

This Guide is intended for experienced operations personnel, having basic knowledge or expertise in ISB. Although widely applicable, this guide reflects research and experience in North American waters.

### **How to Use This Field Guide**

A decision to use ISB with appropriate local, state, and/or federal approvals should already have occurred before field operations commence. The decision to pursue burn should be made early in an incident, taking into account its feasibility and appropriateness, with guidance from Incident Command/Unified Command to make best use of windows of opportunity.

Operations managers should then use this Guide to develop timely plans, brief personnel, and manage operations. Environmental staff

should ensure that the operational plans conform to any permission requirements or permit conditions.

- The included checklists provide guidance to develop operational arrangements to support ISB in marine and other open water locations.
- Verification of continued favorable burning conditions must occur throughout preparations and just prior to ignition. General and habitat-specific listings of such conditions are included.
- The scale of an ISB and its duration will significantly affect the potential hazards, permissions required, operational staffing, management structure, and intensity of any air quality monitoring. This Guide is intended to be incident scale-neutral.
- When encountering unfamiliar terms or acronyms, please refer to the Glossary.
- Appendices provide additional detail on specific operational considerations.



# Field Operations Guide for In-Situ Burning of On-Water Oil Spills

## Introduction

This Guide is intended to assist oil spill responders who are considering or executing controlled in-situ burning of a spill to marine, open waters. In-situ burning (ISB) is the combustion of hydrocarbon vapors from spilled oil, which are converted predominantly to carbon dioxide and water and released to the atmosphere. *In situ* means “in place” in Latin.

The basic objectives of an on-water ISB operation are to:

1. Safely and efficiently remove as much oil as possible from a water surface to reduce environmental impacts;
2. Reduce the movement of spilled oil by wind, wave, tide, or current and subsequent exposure of into more sensitive and/or economically important environments.

This Guide is intended primarily as a field guide for experienced personnel, as opposed to an educational or decision-making tool. It is assumed that users have basic knowledge or expertise in ISB, so the Guide functions primarily as a set of checklists, tools, and references to assist in conduct of ISB.

- The environments addressed in this Guide include open ocean, other large water bodies or inland seas, and near shore locations, with and without ice.
- This Guide is intended for all sizes of incidents, since even small localized incident responses should follow the same basic procedures as a large incident.

## Specific In-Situ Burning Considerations

Tactical decisions as well as the nature and amount of resources needed to conduct a safe and effective burn depend upon the size of the expected burn(s); the volume and condition of the oil spilled; the type of release (i.e. limited event vs. continuing spill); the proximity of

the intended burns to the source; and whether the spill source is already ignited, or could be ignited accidentally.

The safety of personnel will always be of paramount importance. Sometimes safety considerations will drive use of specific procedures for ignition and sustained combustion of highly volatile fluids.

### ***Oil Types***

It is assumed that the type of oil to be burned is crude oil, diesel, or other petroleum product that floats on water, and which can be burned safely. Lighter petroleum products such as gasoline are typically considered too volatile for a safe burn. The condition of the oil, its weathering state and ability to ignite and burn, is key.

### ***Location Considerations***

ISB should be conducted at locations sufficiently removed from an unignited spill source for fire control purposes. Open water or near shore locations are typically far from populated areas. Many open water locations may be conducive to a safe and efficient ISB, and in some situations, burning may be the only means of both quickly and safely removing large amounts of oil.

### ***Requirements to Ignite and Sustain an ISB***

ISB requires fuel, oxygen, and an ignition source. Fuel for a burn is provided by the vaporization of oil, which is increased by the heat from a fire. To sustain a burn, there needs to be adequate oil for continued vapor generation to yield steady-state burning. In addition, it is necessary to have a sufficient thickness of oil to provide insulation against the loss of heat from the oil into the water below. At oil thicknesses of only a millimeter or two, most fairly fresh petroleum products can cool to temperatures below their fire points, releasing insufficient vapors to sustain combustion.

The thicknesses required to ignite and sustain combustion depend upon the volatility of an oil, its emulsification (or water content), and wind and sea state conditions. Ignition of spilled oil is especially dependent upon these conditions because of the limited size and intensity of most ignition devices.

- For a burn to be ignited and sustained on water, the spilled oil must be at least 1/10 in., or 2–3 mm, in thickness. For heavier and emulsified oils up to 10 mm thickness may be necessary to generate burnable vapor concentrations.
- Volatile fractions can quickly evaporate from spilled oil and render it too heavy for a sustained burn. An oil spill over approximately four or five days old may be impossible to ignite or a burn impossible to sustain without use of an accelerant or fire promoter.
- Once ignited, spilled oil will tend to burn down to a thickness of about 1 mm on water.

### **Containment**

Containment of some form is usually necessary to limit spreading of an oil slick and maintain necessary thickness for ignition and sustained burning. Oil slicks can spread quickly on open water to thicknesses of 1/10 mm or less within minutes to hours, depending upon the nature and amount of oil spilled and the wind and sea conditions. Therefore, fire-resistant booms are predominately used to capture and contain oil to thicknesses of at least 5 to 10 mm. Slick thicknesses of 10–20 cm or more, help burn efficiency.

- Other types of physical containment (e.g. ice, debris, shorelines) can provide barriers against spreading of oil to support ISB.
- Ambient winds and chemical herders can also help drive slicks against natural or manmade barriers to thicken oil and support combustion.
- The size of a burn may be sufficient (typically 10s of meters in diameter) to create thermally induced winds moving radially inward toward the center of a burn as hot air rises above the fire. Such winds can transport surrounding surface slicks toward and into the fire, thereby helping sustain and prolong the fire.

## ISB Decision-Making Components

ISB quickly and significantly reduces the amount of spilled oil on water or shoreline, thereby preventing longer environment exposure times or being moved by wind or current with the result of exposing additional natural resources and habitats. ISB can also reduce ground-level volatile air concentrations of oil components thereby making the post-burn work environment safer for response crews.

The decision to pursue and conduct an on-water burn should take into account the feasibility and appropriateness of ISB. Checklists are provided in this Guide to help address issues involving:

- nature and distribution of spilled oil;
- size and condition of the spill source (a batch or continuous release);
- potential for accidental ignition of the source or other facilities nearby;
- environmental conditions which might preclude a successful ignition and sustained burning; etc.

Once it is determined that a safe and effective burn can be conducted, such information can be used by planners to secure appropriate approvals and resources to carry out the burn(s). Once approved, operations managers should share site-specific burn plans, mobilize resources, brief personnel, and coordinate all offshore, shoreline, and air operations.

The focus of this Guide is upon the operational plans and implementation of the ISB, not the decision-making process. The Guide should serve as a field reference and summary of key factors in executing safe and effective controlled burns at sea once the decision to burn has been made and approved.

## ISB Field Operations Checklists

### Including Confirming Planning Considerations

#### General Precautions and Preferred Conditions

- **Winds**—<18 knots (21 mph or 34 km/hr) for ignition; sustained burning possible with higher wind conditions.
- **Wave Height**—less than 3-m swells or 1-m wind waves (may be higher with fresh and un-emulsified oil).
- **Oil**—at least 2 to 3 mm thick (2 to 3 times thicker for highly weathered/emulsified oil).
- **Emulsification**—typically less than 25% water content (can vary for different types of oil).
- **Current**—typically < 0.75 to 1 knot relative velocity between the fire boom and the surface oil/water to avoid entrainment of oil.
- **Ice**—ice cakes and floes with < 10% to 20% coverage. Greater concentrations can interfere with booming operations, filling the collection area and/or damaging booms. Ice can, however, provide natural containment for ISB depending upon the nature and concentration of the ice.

## Prerequisites

- On scene conditions continue to justify, and satisfy requirements for, ISB (Appendix A).
- Human populations are at a safe distance from anticipated fire and smoke (Appendix A).
- The ISB can be conducted safely (Appendix B). A Site Safety Plan specific to the intended burn has been developed, approved, and communicated.
- Weather forecast indicates suitable conditions will persist over the estimated burn-time window (Appendix C).
- Oil on water, ice or shoreline is contained by natural barriers (ice, wind, and geography), or by booms; resulting in oil thicknesses of 2–3 mm or more for successful ignition.
- Wind and open water conditions are favorable for successful containment of oil (minimizing chances of boom failure) (Appendix D).
- Oil is fresh enough and has enough volatile hydrocarbons to allow ignition and there is sufficient oil and vapors for sustained combustion (Appendix E). A test ignition is suggested and may be required.
- Vessels for boom deployment, fire oversight, ignition, rescue, and monitoring are available and adequate in number, type, size, and power (Appendix D, E, and G).
- Federal, state, and local approvals have been obtained; consultations have been made.
- All necessary permits have been obtained and are available on site.
- The Responsible Party/Parties for the spill and incident management have given written consent to conduct of a burn.

## Logistical Considerations

### **Personnel**

- Personnel have been identified and assigned for:
  - Command and Communications.
  - Safety.
  - Oil Containment.
  - Ignition Operations.
  - Surveillance and Spotting.
  - Rescue and Emergency Medical Services.
  - Environmental Protection/Pollution Monitoring.
  - Wildlife Monitoring.
  - Post-Burn Activities (including residue recovery, burn volume estimation, equipment decontamination, etc.).
- Emergency Medical/Rescue and Fire Control Teams have been established.
- ALL personnel are appropriately trained and/or experienced for their roles.
- Appropriate personal protective equipment (PPE) and safety gear are available, distributed, and personnel are trained on its use.
- Hydration, toilets, shelter, and food supplies are available on participating vessels. Plans are in place to provide additional food, fuel, and supplies as necessary.

- Burn area maps and communications call lists have been prepared, verified, and distributed to ALL operations personnel.
- All operations personnel have been briefed on:
  - Safety (including health signs and symptoms of exposure and what to do about it).
  - Ignition and sustained burn plan.
  - Fire control and suppression.
  - Wildlife and environmental protection.
  - Emergency response tactics.

### **Staging**

- Staging areas have been identified. Ports and docks have adequate material handling and resupply capabilities for fire boom, igniters, etc.
- If needed, local heliports or helispots have been identified and marked for:
  - Medical evacuation/Air ambulance procedures.
  - Crew changes and additional personnel needs.
  - Aerial surveillance and spotter support base.
  - Aerial ignition support base (if used).
  - Fuel storage and supply for offshore marine and air operations.
- Radios and cell phone coverage in all parts of the operational area are verified.
- Radio channels are established for:



- Command and Control.
  - Ignition Team.
  - Operational Surveillance & Spotting Teams.
  - Air Quality Monitoring Team.
  - Burn Residue Recovery Team (if used).
  - Other teams, as deemed appropriate and necessary.
- Ignition equipment is in place (Appendix E). In cold conditions, these must be able to provide high-temperature and sustained heat needed to ignite cold oils.

## Location Considerations

### ***Open Water Conditions***

- ISB fire-resistant boom of sufficient durability and length is available (Appendix D), a typical length is 500 ft per burn team towing unit.
- Conventional containment boom is available for diverting or deflecting oil to the burn containment operation.
- Towlines, 200 to 300 ft at each end of the towed U-boom configuration, are available, along with suitable lighting if left deployed overnight.
- Boat or shore access is available for:
  - Boom deployment maintenance & supply.
  - Operational surveillance and spotting.
  - Vessel and/or aerial ignition.
  - Air quality and wildlife monitoring.
  - Rescue teams & backup fire control.

- Recovery and transport of unburned residues.
- Decontamination/cleaning for boats and boom.

### **Ice Conditions**

- For ISB on solid ice:
  - Thickness and integrity of ice has been verified for all operations that require any personnel or equipment on the ice.
  - Chain saws and ice augers are available in the needed sizes.
  - Lifting equipment is available to remove ice blocks from trenches or slots.
  - Storage/containment areas for the ice have been established, if not used as containment or safety barriers on/in the ice.
  - Front-end loaders, ditch-witches, and other heavy equipment for ice & snow modifications on thick stable ice.
  - Underwater lights for locating oil trapped in ice.
- For ISB in broken ice:
  - Adequate ice-strengthened vessels for offshore operations, with skimming systems designed for operations with ice could be needed to recover unburned oil or burn residue.
  - Tracking beacons to monitor any movement of oil and/or oiled ice.
  - Ignition systems (hand-held, terra-torch, helitorch or fixed-wing), depending upon the nature and distribution of the oil and ice.
  - Aerial support to monitor oil/ice conditions, provide spotting for surface operations, and to document all burn operations.

## Monitoring, Notifications, and Documentation

### **Monitoring**

- Air monitoring equipment for particulates, lower explosive limit levels, volatiles, and poly aromatic hydrocarbons are functional, calibrated and deployed (Appendix G).
- Equipment for unburned oil and residue sampling and recovery is identified and in place (e.g. sorbent materials, nets, over-the-side excavators or scoops, viscous oil skimming systems, storage containers, etc.).
- Equipment for recording pre- and post-burn status (cameras, water- and beach-sampling materials as appropriate). Documentation of fire size, location, and duration of burn for oil removal volume estimates. Recording of multiple burns, amount of burn residue produced and collected, etc.

### **Public Safety Notifications**

- Local emergency management and law enforcement agencies have been notified regarding any potential visibility impacts (aircraft, road and waterborne traffic, and spill response personnel).
- FAA has been notified of possible smoke impacts to air traffic, as appropriate.
- Marine safety zone established and Notice to Mariners requested of USCG, as appropriate.
- Potential road closures or detours due to smoke if burning near shore.
- Alerts and possible relocation of residents due to smoke.
- The local 911 public safety organizations have been briefed on the burn(s) and possible smoke concerns.
- A public relations contact has been identified and briefed.

## ISB Plan Components of an Incident Action Plan

- ICS for this ISB has been established (Appendix I).
- Incident Command conditions and requirements for the ISB have been incorporated into plans as appropriate.
- Requirements of all federal, state and local permits have been communicated and incorporated into plans as necessary.
- Site Safety Component** (Appendix B) including:
  - Emergency Contingency Component** covering:
    - Monitoring (wind/sea conditions, visibility, temperature, etc.).
    - Waterborne Fire control (type, amount, and location of vessels/equipment/personnel).
    - Medical/Rescue Resources (air ambulances may not transport contaminated patients).
    - Emergency communications.
    - Rapid notification and evacuation of response personnel.
- Oil Concentration Component** for surface water:
  - The concentration and thickening of oil with barriers or chemical herders to increase efficiency of burn.
  - Preparations for possible continuous burns of oil from large batch releases, continuous sources, the continuous feeding of weathered (low volatility) oil to towed U-boom configurations, and the deliberate ignition of spill sources.
  - The potential for use of icebreaking vessels to access oil beneath solid sea ice.
  - The use of ice penetration, trenching, and removal techniques for the exposure and capture/burning of oil.



**Tow Boats Pulling Fire Boom in a U-Shaped (Catenary) Formation**

*Source: API.*

- The use of chemical herding agents, wind or propeller wash to concentrate oil between ice floes, in leads, in or upstream of fire boom configurations, and along non-vulnerable (or lightly-impacted) shorelines.
- The use of diversion boom to deflect oil in currents towards burn areas.
- The capture of oil with fire boom towed in a U-configuration (Appendix D).
- Use a two-boat configuration moving with current to capture oil in fire boom (boom to have relative velocity to stream flow of  $< 0.7$  knots) for burning.
- In conjunction with the above tactic, two additional boats (more widely separated) can tow conventional deflection boom upstream in an open-apex (or “funnel”) configuration. Oil can then be concentrated over a broader swath, concentrating oil to the fire boom configuration.

- **Oil Collection** requirements with broken ice:
  - Use hand-held vessel-deployed and/or aerially-deployed igniters to ignite oil on ice or between floes.
  
- **Oil Collection** requirements under/in/on solid ice:
  - As ice concentrations increase beyond 20%–30% controlled ISB operations without boom can be done successfully when the ice confining the oil maintains the necessary oil thickness. Wind and chemical herding can assist in maintaining thickness. ISB, in particular, has significant potential for eliminating large quantities of spilled oil safely and effectively under extreme cold conditions, even in the presence of land-fast and offshore pack ice.
  
- **Ignition Plan Component** requirements:
  - Personnel identified.
  - Burn time estimated and ignition timing criteria established.
  - Ignition equipment readiness checked.
  - Ignition tactics identified (examples below).
  - Sequencing of ignition locations to give better control and speed of fire spread depending upon wind direction and safety considerations.
  - For open water, the sequencing and location of ISB actions might include: swath enhancements, towed boom orientation and speed, wind herding, and the use of propeller wash for herding.
  - Consider batch burning for better control of fire propagation. Usually, the use of two or more igniters and/or the use of hotter and longer-lasting igniters will suffice for any stubborn ignition.

- **Aviation Operations** requirements (if used):
  - Aerial observation criteria defined and communicated.
  - Aerial ignition systems operations procedures established.
- **Operational Surveillance** requirements:
  - Observation locations identified upwind of burn area.
  - Personnel and vessels assigned.
  - Action criteria established.
- **Fire Suppression** requirements:
  - Vessels equipped with fire hoses/monitors to drive back oil that gets too close to the vessel.
  - Fire extinguishers on boats, Helitorch staging areas and shore-side burning locations.
  - Personnel assigned.
  - Sufficient water pumping and flow capacity is available when used for suppression.
  - When using towed booms on water, consider a rapid release tow harness.
- **Air Quality Monitoring** requirements (Appendix G):
  - Monitoring locations identified.
  - Personnel and equipment assigned.
  - Monitoring frequency and reporting times established.
  - Action criteria established.
  - QA/QC issues addressed.

- **Post-Burn Activity** requirements (Appendix H):
  - Safety for collection of burn residue is assessed.
  - Evaluate damage of leaving residue vs. safety of responders.
  - Evaluate potential for booming unburned oil into sufficient quantities for another burn.
  - Appropriate equipment are identified (examples below):
    - On open water, residue collection can be performed using as rakes, nets, containment booms, and skimmers and/or sorbents are suitable for heavier oily burn residues.
    - Arrange for interim storage capacity if needed.
  - Arrange for on-water storage capacity if needed. Consider pumping height requirements.
  - Disposition of unburned residue arranged (waste disposal permits and transport).
  - Criteria established for documentation of operations data, pre- and post-burn conditions.
- **Demobilization Component** of the plan has been prepared, reviewed, and approved.
  - Includes provisions for an After Action Review.



### Final Pre-Burn Checklist for Field Command

Action	Completed?
Are ALL planned operations personnel and equipment on-location, available, fueled and operationally ready; including air support?	
Have the Site Safety and Ignition Plans been verbally briefed to ALL personnel?	
Has each worker been briefed on the project objectives, their assignment, safety hazards and mitigations, emergency plans?	
Are ALL permits and clearances obtained and available?	
Has ALL vulnerable infrastructure in the area been identified (e.g. bridges, docks, and marinas)? <ul style="list-style-type: none"> <li>• Locations of all near-shore utility transmission lines communicated to air resources.</li> <li>• Protection is in place for all vulnerable infrastructure.</li> </ul>	
Are current and projected weather forecasts favorable for ISB?	
Are ALL smoke-management specifications met?	
Are ALL emergency contingency resources available: either staged or on standby?	
Can undesirable secondary fires be avoided?	
Are all necessary communications possible?	
Have ALL the required notifications been made?	
Have all the pre-burn conditions of approval been completed or addressed?	
In the ISB field commander's opinion, can the burn be carried out safely, according to plan, and will it and meet objectives?	

## Habitat-Specific ISB Information

### Open Sea and Large Lakes

Typically, burning floating oil on a water surface requires oil be collected into slicks a minimum of 2–3 mm thick and then ignited. Oil is typically collected in fire-resistant booms that are towed through the spill zone by small vessels of less than 2,000 tons displacement. The boom may be towed at 3/4 knot or less during the burning process in order to maintain the proper oil concentration or thickness. In such cases the towing vessels usually move against the wind. Thermocouple probes during the Newfoundland Offshore Burn Experiment showed no increase in water temperatures during the burn. ISB could impact the sea surface microlayer habitat, but circulation and replacement from adjacent and underlying waters result in very limited effects

Surface collecting agents (also called herders) are chemical agents that are applied around the periphery of a spill on water to control the spreading and therefore the thickness of the oil. Use of such agents often requires site specific regulatory approval. In the U.S., surface collecting agents are listed on the EPA National Contingency Plan Product Schedule (40 CFR 300 Subpart J [http://www.epa.gov/osweroe1/content/ncp/product\\_schedule.htm](http://www.epa.gov/osweroe1/content/ncp/product_schedule.htm)).

### Shallow and Near Shore Areas

Oil can be collected and burned the same as in open seas and large lakes if the wind and water depths allow. Responders can take advantage of currents along shorelines and natural collection points to corral oil. In very shallow water, sheet metal can be used to divert slicks. Oil can also be collected in shallow waters and then towed to deeper water for burning.



### **Oil Thickened by Treatment with a Herding Agent**

*Source: Bureau of Safety and Environmental Enforcement.*

Mechanically generated current—i.e. from a vessel's propeller (propeller wash; also referred to as physical herding)—can be effective for collecting and concentrating oil along a shoreline or in a stationary boom attached to a shoreline. Surface collecting agents may also be useful, but are likely to be of greater environmental concern than when used in open waters.

The most inert shore types for ISB are solid rock and man-made surfaces, such as sea walls. ISB is less well suited for mangroves and salt marsh.

- Wind and currents can drive floating oil onto shorelines and those same factors can result the requisite minimum of 2–3 mm thickness necessary for sustained burning.
- Given favorable conditions, stranded oil may be contained by sand berms constructed using earthmoving equipment, at least for long enough to conduct ISB.

### **Cold Climate Considerations**

The burning of oil offshore under cold conditions, especially in the presence of ice, presents unique challenges for

- responders having to work with low temperatures,

- potential need for ice-strengthened vessels,
- potential for slicks to be accessible only in ice leads, and
- possible operations in remote locations (e.g. the Arctic) with periods of low visibility, even months of complete darkness.

While these conditions can hamper operations, they often provide favorable weathering conditions resulting in slower oil slick spread rates, the natural containment of oil by ice, and the encapsulation of oil in ice. Spilled oil can be frozen in place thereby retaining its fresh volatile properties for subsequent efficient burns, recovery at a later time, and possibly even treatment with chemical dispersants.

### **Ice Conditions on Water**

Burning may be the only practical response option in ice conditions. Natural containment of oil can occur in some ice conditions because ice can inhibit the spreading and weathering of oil. At higher ice concentrations, oil spreads slower than on open water. When ice concentrations cover more than 60% to 70% of the water surface, the ice floes pack together closely and provide a high degree of natural containment. As ice concentrations decrease, oil spreading increases until it reaches close to an open-water thickness in drift ice of 30% coverage or less. At higher ice concentrations, the oil spreads slower than on open water. When ice is less concentrated, spreading can still be reduced by the effect of wind herding against natural ice dams or by the judicious use of surface collecting (herding) agents (discussed above).

In some situations oil is trapped under a stable ice sheet. If safe to do so, slots or holes can be cut to allow oil to surface, where it can be burned. Oil spilled early in the ice season will become encapsulated. During spring break-up, trapped and encapsulated oil can migrate through brine channels to the ice surface where it accumulates on melt pools and can be burned. Sometimes it is necessary to track trapped oil under the ice until spring break-up makes it available. Oil spilled on ice spreads much more slowly than on water, resulting in thicker, more burnable slicks.

# **Appendix A**

## **Appropriateness of ISB**

A primary objective for spill response is rapidly removing oil and thereby limiting the magnitude of adverse environmental consequences. Good response decision-making means choosing the least environmentally damaging and most effective response option when a spill occurs. The negative event, the spill, has already occurred and response efforts are focused on ameliorating the consequences.

ISB can be initiated on water if an oil slick is at least 2–3 mm thick. An external igniter is used to heat the oil, generating enough vapors above the surface of the oil to ignite and sustain a burn. It is these vapors—rather than the liquid oil on the water surfaces—that actually burn. When enough oil burns to the point that the remaining oil layer is less than 1–2 mm thick, the fire will self-extinguish. At a lesser thickness, the water under the oil absorbs heat from the fire faster than that heat can volatilize oil to feed the fire.

The time window of opportunity for ISB can vary depending on the weathering state of the oil and local conditions. Experience suggests that the sea state limit for effective burning is < 3 m swells and 1 m wave heights. The ability of fire boom to contain oil is a major factor. Ignition is inhibited in winds >18 knots (37 km/hr or 21 mph) as the oil quickly weathers and emulsifies to beyond a combustible state. Sustained burning may be possible at higher winds if the oil has high volatility.

In some situations, other response options are not effective or may cause more damage. Depending on exposures, components within oil can cause some acute and chronic effects to marine vegetation. While burning will not reduce toxic effects of oiling that occurred prior to a burn, it can be very effective at reducing the extent and degree of additional impact by quickly and efficiently removing the remaining oil.

<b>Major Advantages and Disadvantages of ISB</b>	
<b>Advantages</b>	<b>Disadvantages</b>
Allows rapid removal of oil and more complete removal from inaccessible locations; may be less damaging to the ecosystem than other removal options.	Creates a smoke plume.
Typically requires fewer response resources than most other techniques.	Requires minimum oil thickness to burn, so may require containment.
Minimizes the amount of waste for handling and disposal.	Fire containment may be difficult in certain situations.
Significantly reduces volatile emissions, and reduces response worker and wildlife exposure to emissions	Residues may sink and coat sediments.
Allows for more efficient removal of oil from ice.	

There are four main drivers for considering the use of in-situ burning:

1. Minimizing the spread of spilled oil on a water surface or to impact a shoreline.
2. Rapidly removing surface oil to limit exposure time.
3. Reduced logistics and access constraints relative to other options for offshore spills.
4. Minimizing the volumes of recovered oil that would otherwise need to be handled, transported, and treated; each activity has associated hazards.

### Minimizing the Spread of Oil

Oil should be removed as quickly as possible to prevent its spread and/or to limit exposure to sensitive receptors. Burning can remove oil in minutes to hours to help prevent spreading, whereas skimming oil can take days to months and dispersants don't really remove the oil. Response timing can become critical during certain seasons or in rapidly changing weather/water conditions. For example, forecasted rain can weaken slick integrity and thereby shorten a window of opportunity such that a burn should be conducted prior to forecast rain.

### Rapidly Removing Surface Oil

Effects from oiling are a function of concentration and time. ISB has high removal efficiency, which can greatly shorten exposure times for animals and plants and reduce the concentration of remaining oil. Use of booms or other means to gather or contain surface oil can aid removal efficiencies by creating thicker slicks. Where incomplete combustion is observed, the potential for a repeat burn can be considered.

### Reduced Logistics and Access Constraints

It can be very challenging to provide access for people and equipment. Burning can significantly reduce the oil while incurring much less environmental damage than conventional mechanical recovery.

### Minimizing Waste

Options for temporary storage, handling, transportation, and disposition or disposal of recovered oil and oily wastes can be limited, so the amount of waste generated should be minimized, if possible. *In-situ* burning can be up to 98% efficient at removal for the volume of oil contained based on empirical observations from laboratory, meso-scale and field burns.

During both manual and mechanical cleanup, large volumes of recovered oil and oily waste are generated. Those materials need to be properly and safely handled, which means coordinating temporary storage sites and interim treatment, transportation for any further treatment, and eventual recycling or disposal. Each of these activities has hazards that need to be considered. The remoteness of a site from approved disposal facilities should also be a factor in the decision to burn.



## **Appendix B**

### **Personnel Safety**

A Site Safety Plan component of the Incident Action Plan should be developed specifically for the ISB operation. It can be a stand-alone plan or an attachment to the overall Site Safety Plan for the oil spill incident. The Site Safety Plan must be communicated to all affected personnel prior to the ISB. It should include the following at a minimum:

- PPE required by the role of each person (at a minimum, any field personnel should wear personal flotation devices, fire-resistant clothing, steel-toe rubber boots, neoprene gloves, safety glasses/goggles, and a hard hat. Bunker gear may be required for shoreline response personnel working closest to the fire).
- Requirements for proper hydration, food, and rest periods.
- Heat stress and cold stress management.
- First Aid/medical procedures.
- Hazards of chemicals involved in the burn (oil, herding agents, ignition agents, particulates, etc.).

NOTE: LEL meters do not detect toxic hazards.

- Other site hazards (shoals, sharks, insects, etc.).
- Hazard Monitoring Plan/Air Monitoring Plan/Exposure Limits.
- Site communications.
- Safe work procedures.
- Emergency procedures.
- Site map.

The United States Coast Guard has a template for comprehensive site safety plans for oil and hazardous materials response that uses the ICS form approach. It can be found at:

[http://www.uscg.mil/forms/ics/ICS\\_208\\_CG.pdf](http://www.uscg.mil/forms/ics/ICS_208_CG.pdf).

## Appendix C

### Weather and Smoke Management

Wind (strength, altitude, and direction), precipitation (type and severity), temperature, the presence of ice or snow, wave height, and other climatic conditions can affect whether oil can be ignited and a burn sustained. These conditions can also influence the operational conduct of a burn and the safety issues to be addressed.

The temperature of the surface on which an oil is spilled has a greater influence than air temperature. Temperature will affect the viscosity and therefore the spreading of oil. It also affects the volatility and therefore the ease of ignition.

#### Red Flag Conditions

ISB operations on water should consider that any of the following conditions may result in loss of fire control.

- Wind gusts are >35 knots (40 mph or 65 km/hr).
- Forecast is for sharp increase in wind speed (and therefore sea state) within 12 hours.
- Towing vessels are not maintaining safe distances from each other or from burning oil slick.

#### INDICATIONS OF CHANGING WEATHER CONDITIONS

Responders should be especially attentive to changing conditions, which are indicated by the following:

- Approaching cold fronts are forecasted.
- Cumulonimbus cloud development occurs.
- Sudden calm wind observed.

- Shifting winds are experienced.
- Lenticular clouds or high, fast-moving clouds seen. (Lenticular clouds are a sign of high winds aloft—if they surface they could severely impact the safety of field and aviation personnel, as well as greatly increase fire behavior.)

Changes in these conditions during a burn could indicate a possible fire control concern and could trigger actions to move personnel and vessels further away or to terminate a burn. A Burn Plan should reflect such contingencies.

### EFFECTS OF ATMOSPHERIC STABILITY

**Atmospheric stability has a major effect on the dispersion of ISB plumes.** Turbulence increases the entrainment and mixing of unpolluted air into a plume. Solar radiation also causes rising columns of air (thermals) to form naturally when the air over darker surfaces becomes warmer and rises relative to the colder air that occurs over more reflective adjacent surfaces. The rising thermals of air carry the smoke plume aloft, reducing surface-level exposure. Strong solar radiation and low wind speed provide the best conditions for atmospheric turbulence, as shown in the table below. Stability classes A through C are preferred for ISB. The effect of atmospheric stability and dispersion must be considered relative to the scale of a burn. Small burns and remove locations may be acceptable in less favorable conditions.

Solar radiation has less of an effect near dawn and dusk (< 15 degrees from the horizon), such that during certain times of the year the hours in a day potentially available for the preferred conditions may be limited. In general, burning during night hours is less advisable because the potential for a dense cloud of smoke forming at the surface level increases.

<b>Pasquill-Turner Atmospheric Stability Classes and In-Situ Burning</b>			
<b>Better for ISB</b>		<b>Caution for ISB</b>	
<b>STABILITY CLASS</b>	<b>DEFINITION</b>	<b>STABILITY CLASS</b>	<b>DEFINITION</b>
A	very unstable	D	neutral
B	moderately unstable	E	slightly stable
C	slightly unstable	F	stable

<b>Conditions that Define Pasquill Stability Classes</b>						
<b>SURFACE WINDSPEED</b>		<b>DAYTIME INCOMING SOLAR RADIATION</b>			<b>NIGHTTIME CLOUD COVER</b>	
m/s	mi/hr	Strong	Moderate	Slight	> 50%	< 50%
< 2	< 5	A	A–B	B	E	F
2–3	5–7	A–B	B	C	E	F
3–5	7–11	B	B–C	C	D	E
5–6	11–13	C	C–D	D	D	D
> 6	> 13	C	D	D	D	D

Class D applies to heavily overcast skies, at any wind speed day or night, or when the sun is within 15 degrees of the horizon (dawn and dusk)

Under calm winds, a smoke plume may rise high in the air, depending on the atmospheric stability at the time. A high-rising smoke plume, typically associated with reduced wind speeds, should reduce overall health risks from the plume's particulates. Lower wind speeds also allow better fire control. However, with very calm winds during a large burn, the potential also exists that a cloud of dense smoke will form near the surface, especially on overcast days. This potential increases at night.



### **Smoke Plume Lofting from an ISB in Calm Seas**

*NOBE Experimental Offshore Burn.*

#### WEATHER SERVICE ASSISTANCE

Government meteorologists are often available locally and can usually provide a spot forecast. In the United States, the National Weather Service (NWS) maintains a fire weather webpage where local fire weather forecasts can be obtained and spot forecasts for specific locations can be requested. <http://www.srh.noaa.gov/ridge2/fire/> is the current webpage. The specific webpage URL seems to change occasionally so a search from <http://www.weather.gov> may be necessary.

## **Appendix D**

### **Oil Containment & Fire Safety**

#### FIRE-RESISTANT BOOMS

When oil spills on water are confined with booms to contain oil or increase the spill thickness for ISB, the booms should be fire-resistant. Intrinsically fire-resistant booms are made of fire-resistant materials like ceramic-faced cloth or stainless steel tanks. These booms can be used in ice conditions up to 30% coverage. Another type provides fire resistance through the use of water pumped through the boom to dissipate heat.

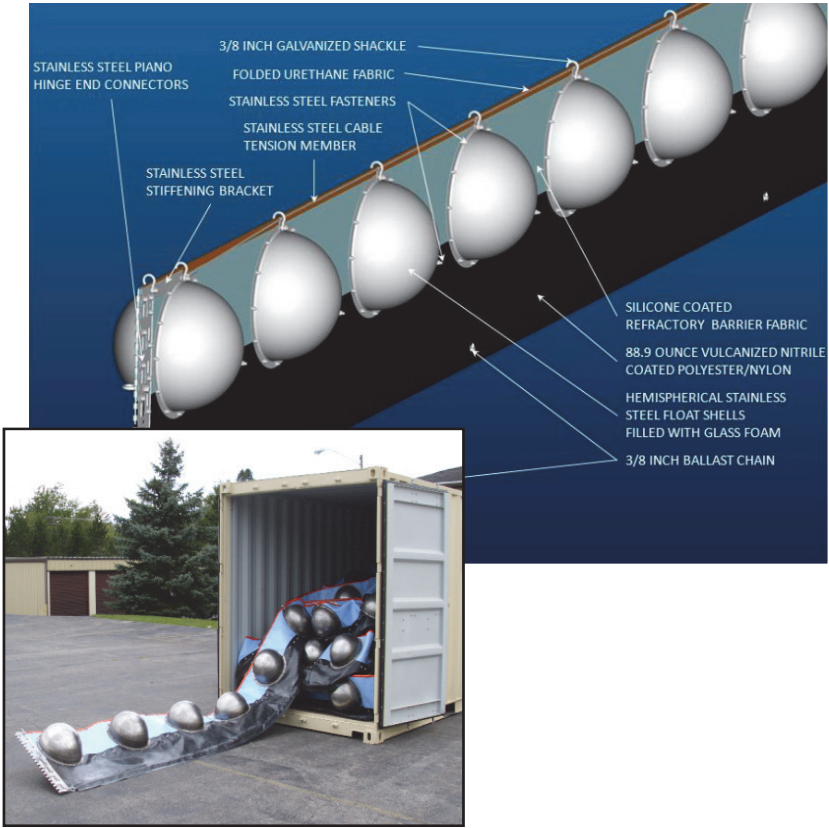

**Fence-Type Boom with Silicone-Coated Refractory Fabric, Aluminum Connectors, and Stainless Steel Floats with Glass Foam**

*Photos courtesy of DESMI-AFTI, Inc.*



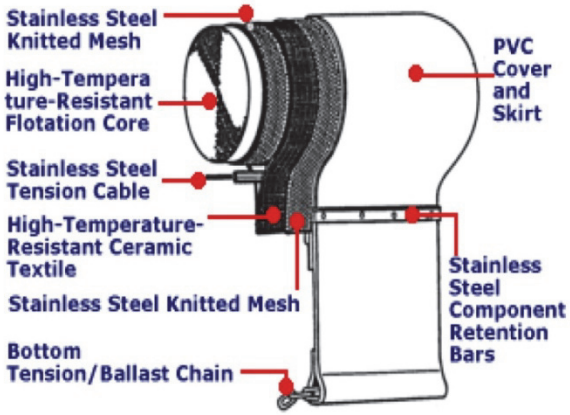

**High-Temperature Ceramic and Stainless Steel Covers with a Solid Flotation Core**

*Photograph and drawing courtesy of Elastec-American Marine.*

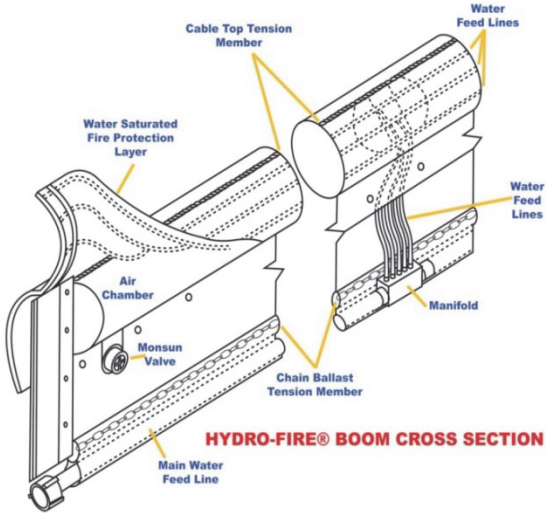

**Water-Cooled Fire Boom that Features a Sectional Inflatable Boom Covered in a Fire Blanket that is Continually Soaked with Water During Burning and is Mounted on a Powered Reel for Both Deployment and Recovery**

*Photograph courtesy of Elastec-American Marine.*

## DESIRABLE CONTAINMENT BOOM ATTRIBUTES

Forces acting on boom include current, wave action, wind and towing stresses. Each such force is proportional to the surface area of the boom impacted times the square of the velocity of each force. The forces are additive. Consequently, all the components of a towed boom array must be capable of withstanding the forces resulting from the selection of component attributes. Towlines should have 7 times the strength of the expected drag forces while towing at 1 knot. Towlines should be long (200 to 500 ft on each end) to minimize the effects of prop wash. The U.S. Coast Guard recommends the following:

<b>Boom Type</b>	<b>Offshore</b>	<b>High-Speed</b>
Minimum Freeboard (in.)	18	12
Minimum Draft (in.)	18	4
Maximum Draft (in.)	30	12
Minimum Reserve Buoyancy: Weight Ratio	8:1	10:1
Minimum Boom Tensile Strength (lb)	20,000	30,000

High-speed booms systems can be towed above the 0.75 knot threshold of typical containment and fire boom, allowing for increased oil recovery rates when used for collecting and feeding oil to ISB being conducted with fire-resistant boom.

## DESIRABLE VESSEL CHARACTERISTICS

In a practical situation the available inventory of vessels may be limited. Nevertheless, when selecting vessels and roles for them the following characteristics should be considered.

- Vessels assigned to tow boom should have sufficient towing power.
- Vessels assigned to tow should be able to maintain slow speeds (3/4 knot) while retaining maneuverability.

- Vessels assigned to tow should have a small turning radius and short stopping distance.
- Vessels should be seaworthy for the anticipated weather conditions.
- Vessels should have sufficient operational duration (fuel capacity).
- Vessels should have the capacity to support the number of personnel needed to perform the assigned task.
- Vessels should have the requisite deck space and lifting capability to safely support its assigned role. This may vary depending upon whether boom is being launched and recovered at sea or if ancillary power supplies and pumps are necessary for the types of boom used.
- For vessels assigned to work in shallow waters, vessel draft is a consideration.
- It is advantageous to have at least one vessel with the water pumping capacity to support a fire hose or monitor nozzle if fire suppression of an ISB is needed.

### TACTICAL CONSIDERATIONS

- Support vessels should avoid positions behind boats towing active ISB boom system in case of wind shift.
- The direction of active ISB tow vessels should be into the wind or at most 90 degrees to the wind to prevent exposure of the crews to the smoke plume.
- One of the tow vessels should be designated as lead with responsibility of coordinating course and speed changes.
- A support vessel should be part of each ISB burn task force to periodically survey the condition of the fire-resistant boom, backup in case of tow vessel failure and to recover residue as appropriate.

- Tow vessel speed can control the thickness of the oil being burned. A thicker layer of oil burns more efficiently.

## BOOM DEPLOYMENT

In most in situ burns, spilled oil is concentrated by containment to achieve the optimal thickness level. On open water fire-resistant boom contains oil best when deployed in a catenary mode and towed at speeds of less than 0.35 m/s (~3/4 knot) (ASTM, 2007). At greater speeds, oil is lost under the boom.

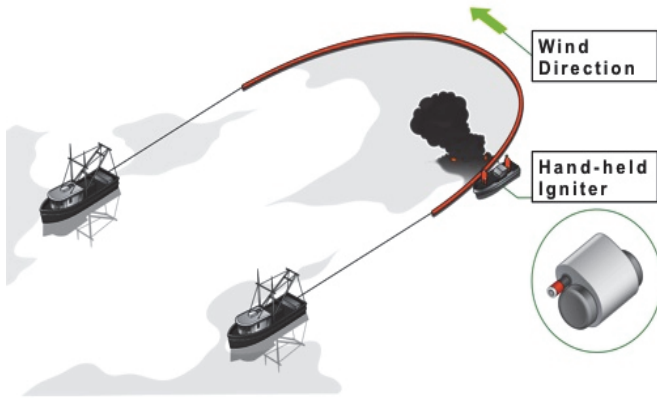

**Fire Boom Towed in a U Configuration**

*Drawing courtesy of BP.*

Two vessels are usually used. The vessel with more power and maneuverability should be used to tow the boom around the floating oil. Ideally it would be able to use drive propellers, bow and stern thrusters to turn in its own length.

The second vessel that pulls the other end of the boom can be smaller. The boom is deployed over the stern of the primary vessel with a buoy on the free end tow rope of the boom. When the boom is fully deployed, the primary vessel tows it while turning around the oil slick so that the boom forms a U or catenary curve as seen from

above. During this operation there is low strain on the boom. The second vessel then picks up the buoy on the free end of the boom, steers a parallel course with the primary vessel about 1/3 of the boom length apart and maintains position for the required configuration.

Booms are usually first deployed from shore, dock or a larger support vessel and towed in line behind to the ISB site. Recovery of oiled or burned boom is difficult and messy. Reuse is often impractical. Minor oiling may be cleaned using steam or compatible solvents. Used fire boom is most often disposed of.

### FIRE SAFETY—FIRE SUPPRESSION

The basic principal for extinguishing an ISB on water is to reduce the thickness of the oil layer below that required to sustain combustion.

- For towed ISB, towing vessels can speed up and allow oil to entrain under the boom.

Alternatively one of the vessels can drop its towline allowing the oil to escape the boom, thin out and self-extinguish.

- For uncontained burns, a vessel can use its wake to separate unburned oil from the active fire.
- Fire hoses and monitors on vessels can also be used to break up the oil slick to separate burning from unburned oil and to spread the oil out so it will self-extinguish.

### EFFECTS OF COMBUSTION HEAT ON SPILL RESPONDERS

In-situ burning of oil produces large amounts of heat, which is transferred into the environment through convection and radiation. About 90% of the heat is convected into the atmosphere. The remainder is radiated from the fire in all directions. Heat radiated towards responders can be a cause of heat exhaustion and burns to unprotected skin. Of lesser concern is heat transferred downward, which might affect water column resources.

The potential for causing injury to exposed workers is a function of both the level of heat and the duration of exposure. Wood will char if positioned about half a fire diameter from the edge of an oil burn.

The safe approach distance to an in-situ oil fire is from two to four times the diameter of the fire, depending on the duration of exposure, as shown in the table below. Conservatively, it is assumed that the safe approach distance to the edge of an in-situ oil fire is approximately four fire diameters.

<b>Safe Approach Distances for In-Situ Oil Fires</b>	
<b>Exposure time</b>	<b>Safe approach distance for personnel (fire diameters)</b>
<b>Infinite</b>	<b>4</b>
<b>30 min</b>	<b>3</b>
<b>5 min</b>	<b>2</b>

*Source: Buist et al., 2003.*

It is important to recognize that oil contained in a towed boom is relatively thick in early stages of a burn and that this thickness is maintained by towing or holding vessel position relative on oncoming current. If the towing was to stop or slow or the boom was to break, then this thick layer would spread quickly to cover an area several times that of the originally boomed oil. This will increase the fire diameter, the heat flux from the fire, and the need for responders to move further away to avoid injury or discomfort.







## Appendix E

### Ignition of ISB

The primary equipment needed to burn a spill is an ignition source. In general, an ignition device must meet two basic criteria in order to be effective: It must apply sufficient heat to produce enough oil vapors to ignite the oil and then keep it burning, and it must be safe to use. Ignition sources range in sophistication from matches to Helitorch (ignited gelled fuel dispensers) suspended under helicopters.

- Propane or butane torches and weed burners have been used to ignite oil, but such compressed gas torches tend to blow thin oil slicks on water away from the flames. They work better with thick, contained oil.
- Fuel-soaked rags or sorbent pads can also be used for ignition. Diesel is more effective as a fuel than gasoline because it burns longer and thus supplies more sustained heat to the oil. It is also less volatile and much safer to use. For emulsified oil up to 40% water content, gelled crude oil is preferred.
- Quart bottles of gelled gasoline or diesel, which are taped to a flare, have been used for on-water ignition. Delay fuses are a desirable safety feature.



-  **Pre-load gelling component**
-  **Remove plug/cap and add 1/2 gallon (2 L) diesel fuel**
-  **Recap and shake to mix**
-  **Uncap, fill with diesel recap and mix**
-  **Insert common marine flare pointed to bottom of container**
-  **Light flare according to directions**

*Courtesy of BP.*



- Another hand-made device that can be floated by a towing vessel into oil contained by a boom is a marine flare taped between two plastic jugs to provide it with flotation.
- For weathered oil, a sorbent (polypropylene) boom coiled and soaked with diesel can be used with the igniter placed on top.
- Commercial handheld ignition devices may be available. These tend to go into and out of production frequently. Elastec and DESMI-AFTI are recent manufacturers. An Internet search is probably the best approach to finding those that are currently available.
- Originally designed and used for forest fire response, the most sophisticated commercial devices used today for igniting oil spills in less accessible situations are the helitorch igniters. These are helicopter-slung devices that emit a stream of burning, gelled fuel and produce an 800°C flame that lasts up to 6 minutes. The stream of burning gelled fuel breaks up into individual globules before hitting the oil. A commercial gelling agent (e.g. Fire-Trol, SureFire, Petro Jel, and Flash21) is often mixed with gasoline, diesel, or crude oil to produce gelled fuel used in these devices. Helitorch igniters were developed for the forest industry and are commonly available with a 110 to 1100 L (30 to 300 gal) fuel tank capacity.

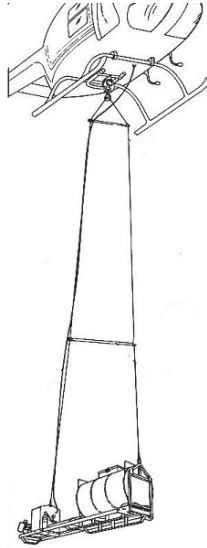

Source: USDA.

- Flame spread rates are affected as follows in quiescent conditions:
  - As oil weathering increases, ignition time increases.
  - Ignition times decrease with increasing slick thickness.
  - Increasing viscosity reduces flame spread rates at a constant thickness and flash point.

Research and development is ongoing to develop improved high-speed ignition systems for deployment from fixed wing aircraft platforms.

If possible, it is often advisable to conduct a limited test burn to confirm ignitability under prevailing conditions. Weathered and/or emulsified oils may require initial thicknesses of several millimeters as well as larger than normal ignition areas. Test burn observations can indicate that it may be beneficial to:

- Deploy two or more hand-held igniters per ignition operation;

- Use a hotter and long-lasting igniter;
- Momentarily hover with a Helitorch to produce a larger ignition area; or
- Provide a brief protection of the ignition site from strong winds using the lee side of a large vessel.

## Appendix F

### Efficiency and Burn Volume Estimation

Calculations of burn efficiency provide a means to determine whether a repeat burn may be appropriate, for performance assessment, and to improve conduct of burns. Burn efficiency is measured as the percentage of oil removed compared to the amount of residue left after a burn. If the quantity of hydrocarbon vapor from a spill is too low, then a burn will not continue to ignite more oil and it will self-extinguish. The amount of vapor produced during a burn depends on the degree of heat radiated back to the oil.

For oil spills on water or other relatively even and flat surfaces, Efficiency (**E**) can be calculated by Equation #1.

$$\text{Equation \#1} \quad E = \frac{V_i - V_f}{V_i}$$

Where

**V<sub>i</sub>** is the initial volume of oil that was burned,

**V<sub>f</sub>** is the volume of residual oil remaining after burning.

The initial volume of oil, **V<sub>i</sub>**, may be known from inventory measurements. If that is not available or reliable, then the area of an oil slick can be estimated visually using objects of known dimension (e.g. a response vessel or a structure) or using timed over-flights, aerial photographs, or remote sensing. The surface area of the spilled oil can be multiplied by an estimate of average slick thickness to yield an estimated slick volume. Thickness can be estimated by taking samples, visually using objects of known dimension, or by remote sensing.

The volume of residual oil remaining after burning, **V<sub>f</sub>**, can be estimated by observation in the same manner. If residue remains afloat, it can be recovered either by skimmers or sorbents and estimated by measuring the volume or weight recovered. If residue cannot be recovered, its volume can be estimated in the same way as for the initial volume of oil. It should be noted that Equation #1

does not account for the volume of oil lost through soot released in a smoke plume during a burn, which is a small amount and difficult to measure, or any residue that has sunk or cannot be collected.

When measuring average residue thickness is impractical, an approach to estimating burned volume is to use Equation #2 and a range of empirical burn efficiency coefficients.

**Equation #2**       $V_i - V_f = A \times E \times T$

Where

**$V_i - V_f$**  is the estimate of the amount of burned oil in gallons,

**A** is the area of burned oil in square feet,

**E** is the assumed burning efficiency rate (a range from 0.07 to 0.05 gallons/minute/square foot, and

**T** is the duration of the burn in minutes.

Minimum and maximum estimates can be determined using the coefficients.

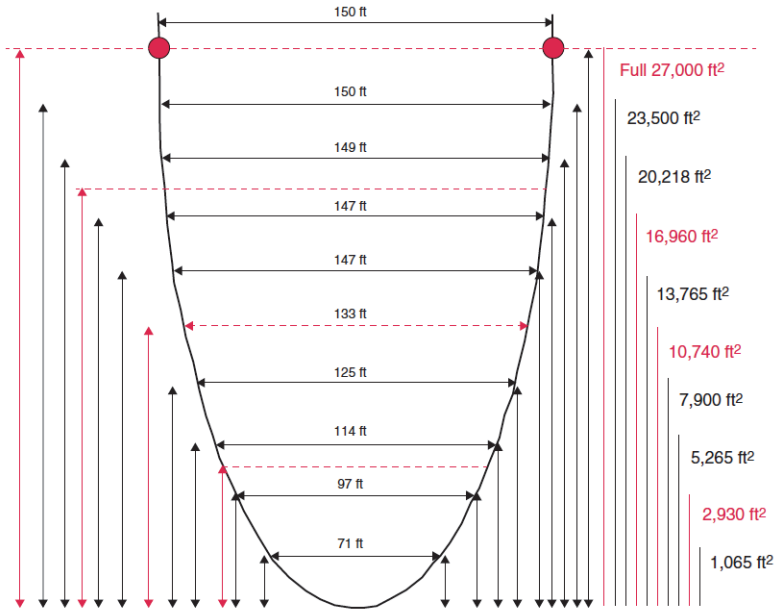

**Estimation of Area Contained in 500 ft of Boom in a Catenary or “U” Configuration**

*Source: Al Allen.*

Oil burns at a rate of about 3.7 mm per minute or about 100 gallons per square foot per day (ASTM F1788). The rate has been shown to be relatively independent of physical conditions and oil types. A catenary boom configuration continuously kept about 1/4 full will burn about 7,500 bbl in 12 hours.

# Appendix G

## Air Quality Monitoring

ISB primarily produces carbon dioxide (73%) and water vapor (12%), which are released to the atmosphere. Particulates commonly account for about 10% of the original volume burned. Gaseous compounds are emitted in minor amounts, including carbon monoxide (3%), sulfur dioxide (1%), and other compounds totaling less than 1%, which includes nitrogen oxides and PAHs. Typically, about half of the particulates in a smoke plume are from soot. Soot is responsible for the dark or black appearance of smoke and is composed of carbon and possibly incompletely combusted compounds.

Air sampling is not necessarily a requirement for the approval of ISB. Proximity to receptors and the scale of the burn are factors to be considered in the decision and permission process. However, real-time monitoring of emissions during an ISB provides continuous feedback as to whether the burn is progressing properly and safely. A well-planned monitoring program during which data are recorded before, during, and after a burn will also help answer questions arising after a burn operation is completed. SMART (Special Monitoring of Applied Response Technologies) protocols provide guidance for rapid collection and reporting of real-time air-quality information to assist the IC with decision making. See [http://response.restoration.noaa.gov/sites/default/files/SMART\\_protocol.pdf](http://response.restoration.noaa.gov/sites/default/files/SMART_protocol.pdf).

### MONITORING OPERATIONS

SMART protocols recommend at least three monitoring teams for large-scale (Tier 2 and tier 3) burns. Each team uses real-time particulate monitors capable of detecting at least PM<sub>10</sub>, if not PM<sub>2.5</sub>. The instruments provide instantaneous readings of particulate concentrations, as well as a time-weighted average (TWA) over the time that the instrument has been logging data. Each team should have a global positioning system (GPS) device, and other equipment for collecting, averaging, and documenting the data. In addition to automatic data loggers, manual recording should occur every few minutes and be reported through ICS channels at each new location and whenever a significant change occurs.

In smaller scale incidents, monitoring should occur at least downwind of the burn but upwind of population centers or other sensitive locations. If there is no potential for human exposure, air sampling using SMART protocols is not needed.

### HEALTH ACTION LEVELS

The U.S. EPA has set human health standards for inhalation of soot, or particulate matter (PM). There are two particulate matter thresholds: PM<sub>10</sub> and PM<sub>2.5</sub>, which are parameters deemed protective for public exposure [[National Ambient Air Quality Standards](#) (NAAQS)]. The existing NAAQS exposure thresholds are designed for continuous sources such as industry and motor vehicle emissions. In contrast, in-situ burning will predominantly occur over a short period of time and as a single event.

Responders can also use guidance provided by the National Response Team (NRT) to interpret the data and formulate recommendations. The NRT recommends a conservative upper limit of 150 µg of PM<sub>10</sub> per cubic meter of air, averaged over 1 hour. This level of concern does not define a threshold between safe and unsafe conditions, but should be used as a general guideline. If it is exceeded substantially, human exposure to particulates may be elevated to a degree that justifies terminating the burn or moving responders or other personnel to a safe distance. However, if particulate levels remain generally below the recommended limit with few or no transitory excursions above it, there is no reason to believe that the population is being exposed to particulate concentrations above the EPA's NAAQS.



National Ambient Air Quality Standards for Particulate Matter				
Particulate Diameter (microns)	Primary Standards		Secondary Standards	
	Level	Averaging Time	Level	Averaging Time
PM <sub>10</sub>	150 µg/m <sup>3</sup>	24-hour <sup>(1)</sup>	Same as primary	
PM <sub>2.5</sub>	15 µg/m <sup>3</sup>	Annual <sup>(2)</sup> (Arithmetic Average)	Same as primary	
	35 µg/m <sup>3</sup>	24-hour <sup>(3)</sup>	Same as primary	

Source: <http://www.epa.gov/air/criteria.html>

- (1) Not to be exceeded more than once per year on average over 3 years.
- (2) To attain this standard, the 3-year average of the weighted annual mean PM<sub>2.5</sub> concentrations from single or multiple community-oriented monitors must not exceed 15.0 µg/m<sup>3</sup>.
- (3) To attain this standard, the 3-year average of the 98th percentile of 24-hour concentrations at each population-oriented monitor within an area must not exceed 35 µg/m<sup>3</sup> (effective December 17, 2006).

## CRITERIA FOR PARTICULATE MONITORS

- Rugged and portable: The monitor should be suitable for fieldwork, be able to withstand shock, and be easily transportable in a vehicle, small boat, or helicopter. Maximum size of the packaged instrument should not exceed that of a carry-on piece of luggage.
- Operating temperature: 15–120°F.
- Suitability: The instrument should be suitable for the media measured, e.g. smoke particulates.
- Operating duration: 8 hours or more.
- Readout: The instrument should provide real-time, continuous readings, as well as time-weighted average readings, in µg/m<sup>3</sup>.

- **Data logging:** The instrument should provide data logging for 8 hours or more.
- **Reliability:** The instrument should be based on tried-and-true technology and operate as specified. Should be tolerant of high humidity environments and water resistance is desirable.
- **Sensitivity:** A minimum sensitivity of  $1 \mu\text{g}/\text{m}^3$ .
- **Concentration range:** At least  $1\text{--}40,000 \mu\text{g}/\text{m}^3$ .
- **Data download:** The instrument should be compatible with readily available computer technology, and provide software for downloading data.



**Example of a Field-Deployable Particulate Monitor that Uses Light Scattering Technology**

*Photo source: USDA Forest Service.*

# Appendix H

## Unburned Oil & Post-Burn Residue Recovery

Collection of unburned oil or burn residue after an ISB is the primary post-burn activity. When the remaining unburned oil can be gathered either naturally or mechanically to a thickness of at least 2–3 mm, a re-burn may be attempted by combining and collecting with other oil to be burned. Follow the same process for re-burns as for an initial burn.

Eventually oil on water will be of insufficient thickness and/or volatility to sustain burning. Studies have shown that residue contains fewer volatiles than the initial oil, but heavier constituents [such as polyaromatic hydrocarbons (PAHs)] remain in the same relative proportion as in the initial spill. Residue often has the composition and appearance of highly weathered oil of the same type.

Upon completion of burning operations, burn residue should be collected and placed in suitable containers for subsequent transport to an approved storage site and ultimate disposal facility. Careful consideration should be given to the possible release of burn residue constituents without recovery.

- The residue of heavier oils will result in heavy residues which may sink in surface waters. Recovery may be possible using nets.
- Medium oil burn residues may form mats or sticky accumulations that can be recovered using nets, boom and manual tools.
- Lighter oil burn residues which are still liquid can be recovered using mechanical skimmers and sorbents.

Studies have shown that ISB on surface waters does not increase toxic oil constituent concentrations in waters under the burn as compared to not burning. Thermocouple probes in the water during the Newfoundland Offshore Burn Experiment showed no increase in water temperatures during the burn. ISB may impact the water surface microlayer habitat, but circulation and organism replacement from adjacent and underlying waters result in very limited effects. The sinking of only a few percent of each burn and the impacts of

such low-toxicity, tar-like material in certain environments should be compared to the benefits of allowing burn teams to save time during on water operations by not stopping to collect residue. Preplanning and the use of Checklists as provided in this Guide should help assess the pros and cons of residue collection.

# **Appendix I**

## **Incident Command for ISB**

The command structure for the resources engaged in ISB operations should be clearly provided in an Incident Action Plan (IAP). The IAP should be developed and approved for the operational period in which the ISB operations are to be conducted, and should include an ISB Operations (or Burn) Plan specifically developed to address ISB operations. If it is a separate document, the Operations Plan should be clearly referenced in the applicable IAP.

In general, the ISB operations' tactical resources consist of single resources or task forces following the Incident Command System (ICS). Task forces are created to accomplish specific tasks (e.g. create fire breaks around the designated burn area). The type and number of resources required will depend on the amount of oil to be burned, the area available for ISB operations, and the number of resources available.

At a complex incident, these resources are usually organized into an ISB Operations Group which is supervised by an ISB Operations Group Supervisor. Span-of-control principles should always be followed when creating the ISB Operations Group. The ISB Operations Group Supervisor reports to either the Operations Section Chief or to the Recovery and Protection Branch Director, if established for large incidents. If burn residue recovery is required, those assigned resources should be appropriately organized in the Operations Section. An example ICS organization for larger, complex burns is shown below.

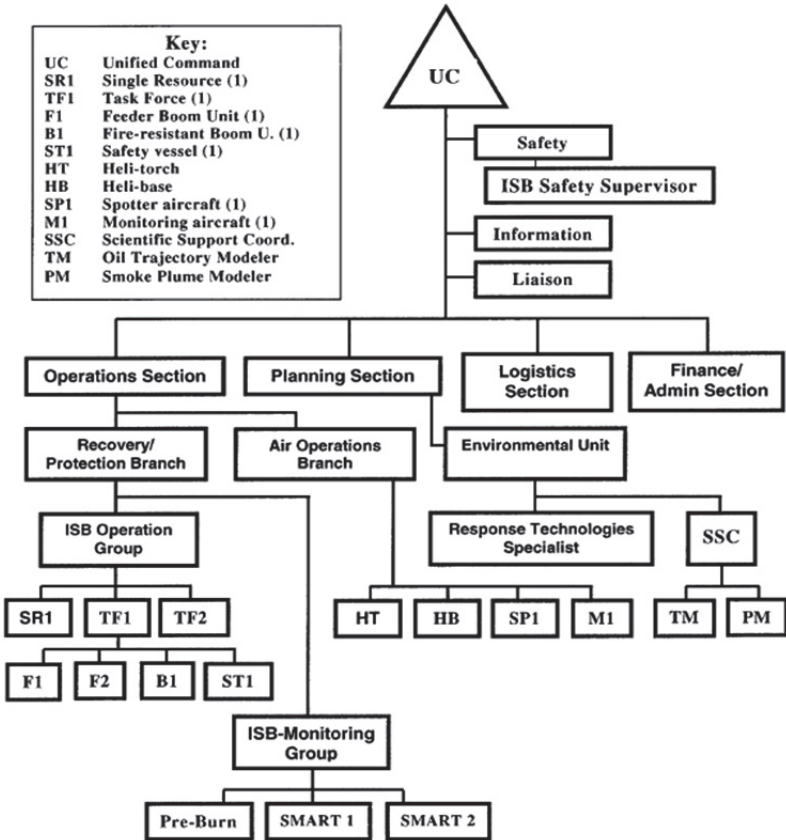

Example of Larger ICS Organization for ISB

All aircraft resources, including aerial ignition platforms and monitoring helicopters, should be assigned to the Air Operations Branch and should support the ISB operations from that position in the ICS organization.

Smaller burns can be managed with a more compact organization, as shown below, as long as span of control limits are observed.

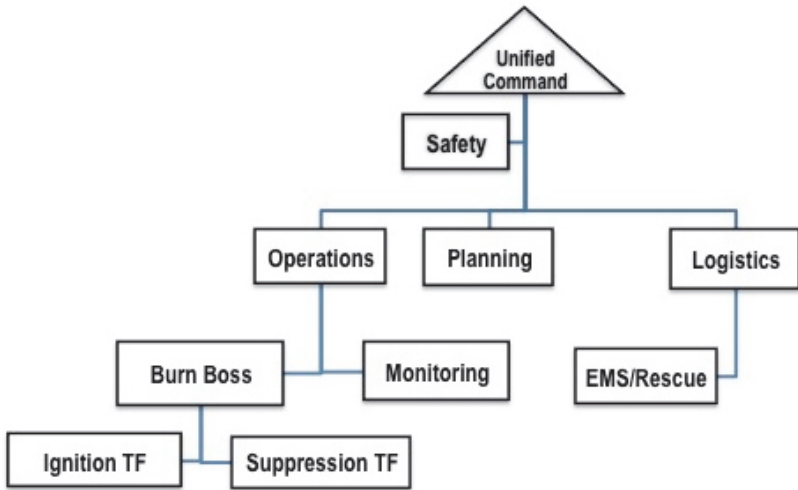

### Example of Smaller ICS Organization for ISB

#### SPECIALIZED ICS ROLES FOR ISB:

- **Burn Boss/Ignition Specialist/Firing Boss:** reports to the Operations Section Chief or Branch Director—This person is responsible for determining the type of ignition pattern needed to accomplish the objectives, when ignition should occur, and where suppression crews should be placed.

This position has complete authority for and directs the firing operation, develops firing plan(s), performs the initial briefing from the firing plan, covers the assignments of each boss/supervisor (and pilot when using aerial ignition). This position also instructs the igniters/ignition team (or pilot) on the firing sequences and keeps them informed throughout the entire operation. For helitorch operations, the pilot is usually the only person onboard the aircraft.

- **Igniters/Ignition Team/Ignition Crew:** reports to the Burn Boss—Their primary responsibility is to ignite the burn area under the Burn Boss's direction. They may also serve as a second suppression crew.
- **Fire Suppression Crew:** reports to the Burn Boss—This crew is responsible for patrolling downwind of the fire to check for spot fires and put them out. The Burn Boss should tell them where the greatest danger may be, but they should be aware that spot fires can occur anywhere. If the Suppression Crew finds a spot fire outside the planned burn area, all ignition is stopped until the spot fire is controlled.
- **Air Quality Monitoring Team:** These personnel collect visual and air quality data at locations specified in the burn plan and as directed during the course of a burn. They maintain communications with the Burn Boss and command post, relaying visual burn progress and analytical data (most likely particulate and perhaps vapor levels). They assure QA/QC of monitoring data and safety at the monitoring locations. They may collect long-term samples for later lab processing, if specified in the monitoring plan.

For additional information on specialized ICS roles for ISB, please refer to API Technical Report 1253, *Selection and Training Guidelines for In-Situ Burn Personnel*.



# Glossary

Term	Definition
Absorbent [the process is called absorption]	A material that picks up and retains a liquid distributed throughout its' molecular structure causing the solid to swell (50% or more). The absorbent is at least 70% insoluble in excess fluid. (ASTM F726-99)
Accelerant (or promoter)	A volatile substance, such as diesel fuel or gasoline, applied on a weathered or viscous oil to provide initial vapor concentrations sufficient to ignite a burn.
Acute effects	Health effects which occur within minutes to hours of exposure.
Adsorbent [the process is called adsorption]	An insoluble material that is coated by a liquid on its' surface including pores and capillaries without swelling more than 50% in excess liquid. (ASTM F726-99)
Atmospheric inversion	Usually refers to an increase in temperature with height in the atmosphere, which is opposed to the normal temperature decrease. It can suppress convection and trap polluted air near the ground.
Boom	Floating, usually tubular, barriers for the containment, diversion, deflection and absorption of spreading liquids. Some boom has non-floating skirts that hang underneath to keep oil from slipping under the floating portion.
Bunker gear	Also known as turnout gear is outer clothing specifically designed for firefighters to provide thermal protection.
Burn Boss	The person in overall charge of in situ burn operations at a location. See Appendix I.
Catenary	A curve formed by a perfectly flexible, uniformly dense and un-stretchable cable suspended by its endpoints.

Term	Definition
Chronic effects	Sublethal health effects which occur within weeks to years after exposure.
Containment boom	A temporary floating barrier used to contain an oil spill.
Convection	Mixing of gas or fluid due to temperature differences.
Cumulonimbus cloud	A dense towering vertical cloud associated with thunderstorms, lightening, gusts, hail, and atmospheric instability.
Diversion boom/ deflection boom	Placing a boom in a body of contaminated water for the purpose of diverting oil to a collection point or away from a sensitive area.
Emulsion/ emulsified oil	The formation of a water-in-oil mixture. This occurs over time as the oil weathers and surface mixing occurs. Oil viscosity greatly increases making collection and pumping the emulsion very difficult. Some emulsions can contain up to 70% water and they can become stable and not separate unless heat or chemical demulsifiers are applied.
Entrainment	The loss of oil under a containment boom when it is pulled along by the water current passing below. Entrainment typically occurs from booms are deployed perpendicular to the water flow.
Fire boom	Fire-resistant boom. See Appendix D.
Herding agent [AKA, surface collecting agent]	A product that pushes or compresses an oil slick on the water surface by exerting a higher spreading pressure than the oil.
Helispot	A natural or improved takeoff and landing area intended for temporary helicopter use.
Helitorch	Helicopter-slung devices that emit a stream of burning, gelled fuel, used for ignition.

Term	Definition
IC	Incident Commander is the person with overall responsibility for all aspects of an emergency response.
ICS	Incident Command System is a management system used for the command, control, and coordination of emergency response (required by law in the U.S.).
Lenticular cloud	stationary lens-shaped clouds that form at high altitudes, normally in perpendicular alignment to the wind direction.
Lower explosive limit (LEL)	Lowest concentration of a vapor for a given material that will support combustion.
Oil sorbent	A material used to absorb oil but not water.
Particulates/ particulate matter	Tiny, solid matter suspended which can be in air.
PM <sub>10</sub>	Particulate matter with diameter of $\leq 10 \mu\text{m}$ which can penetrate the deepest part of the lungs such as the bronchioles or alveoli.
PM <sub>2.5</sub>	Particulate matter with diameter of $\leq 2.5 \mu\text{m}$ , which tends to penetrate even further than PM-10 into the gas exchange regions of the lung.
PPE	Personal Protective Equipment refers to personal protective clothing, helmets, goggles, or other garments or equipment designed to protect the wearer's body from injury.
Polyaromatic hydrocarbon compounds [AKA, polycyclic aromatic hydrocarbons (PAHs) or polynuclear aromatic hydrocarbons (PNAs)]	Hydrocarbon compounds found in oil which consist of fused aromatic rings and do not contain atoms of other elements. They are of concern because some compounds have been identified as carcinogenic, mutagenic, and teratogenic with prolonged exposure.

Term	Definition
Propeller wash herding	Movement of an oil slick using the hydraulic force of a boat engine propeller or bow wave to create a current in the underlying water.
SMART protocol	Special Monitoring of Applied Response Technologies. A program for collecting monitoring data for ISB and dispersant use operations.
Sorbent	An insoluble material or mixture of materials used to recover liquids through the mechanisms of Absorption or Adsorption or both. (ASTM F726-99)
Strike Team	ICS term referring to specified combinations of the same kind and type of response resources, with communications, and a leader.
Task Force	ICS term referring to any combination or single resources assembled for a particular tactical need, with common communications and a leader. A Task Force may be pre-established and sent to an incident, or formed at an incident.
UC	Unified Command is used when there is more than one party or agency with incident jurisdiction. Organizations work together through the designated members of the Unified Command, often the senior person from agencies and/or parties participating in the Unified Command, to establish a common set of objectives and strategies in a single Incident Action Plan.
Viscosity	Property of a fluid that resists flow.
Volatiles/volatile organic compounds	Organic (carbon) chemical molecules having a high vapor pressure.
Weathering (oil)	A combination of physical and environmental processes affecting oil such as evaporation, emulsification, dissolution and dispersion that acts on spilled oil to change its physical properties and composition.

## References

- American Petroleum Institute (API) Publication 4740, 2015. *In-Situ Burning: A Decision-makers Guide to In-situ Burning*.
- API Publication 4735, 2005. *In-Situ Burning: The Fate of Burned Oil*.
- API Technical Report 1251, 2015. *Field Operations Guide for In-Situ Burning of Inland Oil Spills*.
- API Technical Report 1253, 2015. *Selection and Training Guidelines for In-Situ Burn Personnel*.
- API Technical Report 1254, 2015. *In-Situ Burn Guidance for Safety Officers and Safety and Health Professionals*.
- Barnea, N., 1999. *Health and Safety Aspects of In-Situ Burning of Oil, United States*, National Oceanic and Atmospheric Administration.
- Buist, I., 2003. *Oil Spill Response Offshore, In-Situ Burn Operations Manual*, U.S. Coast Guard, Ft. Belvoir: Defense Technical Information Center.
- Buist, I.A., Potter, S.G., Trudel, B.K., Walker, A.H., Scholz, D.K., Brandvik, P.J., Fritt-Rasmussen, J., Allen, A.A., Smith, P., 2013, *In Situ Burning In Ice Affected Waters: A Technology Summary and Lessons Learned from Key Experiments*, Final Report 7.1.2 for the Arctic Oil Spill Response Technology—Joint Industry Program.
- ExxonMobil. 2008. *Oil Spill Response Field Manual*. ExxonMobil Research and Engineering Company, Fairfax, VA.
- Fingas, M.F., 1998. *In Situ Burning of Oil Spills: A Historical Perspective*, National Institute of Standards and Testing (NIST) Special Publication 935, In Situ Burning of Oil Spills Workshop Proceedings.
- International Maritime Organization (IMO), 2011 (Draft). *Guideline for Oil Spill Response Offshore In-Situ Burning*, International Maritime Organization, London, UK.

Mabile, N., 2012. *Controlled in-situ burning: transition from alternative technology to conventional spill response option*. Proc. of the 33rd Arctic and Marine Oilspill Program Technical Seminar, Appendix A. Environment Canada, Ottawa, Canada.

Mabile, N. 2013. *Considerations for the Application of Controlled In-Situ Burning*, Society of Petroleum Engineers, Oil and Gas Facilities, 2(2):72–84.

McCourt, J., I. Buist, and S. Buffington, 2000. *Results of Laboratory Tests on the Potential for Using In Situ Burning on Seventeen Crude Oils*, Proceedings of the 23rd Arctic and Marine Oilspill Program Technical Seminar, Environment Canada, Ottawa. pp. 917–922.

U.S. National Response Team (NRT), 1998. *Bibliography on In-Situ Burning*, National Response Team—Science and Technology Committee, Revised, Washington, DC.

USCG, 2003. *Oil Spill Response Offshore, In-Situ Burn Operations Manual*, U.S. Coast Guard Report No. CG-D-06-03. Research and Development Center. Groton, CT.





AMERICAN PETROLEUM INSTITUTE

1220 L Street, NW  
Washington, DC 20005-4070  
USA

202-682-8000

**Additional copies are available online at [www.api.org/pubs](http://www.api.org/pubs)**

Phone Orders: 1-800-854-7179 (Toll-free in the U.S. and Canada)  
303-397-7956 (Local and International)  
Fax Orders: 303-397-2740

Information about API publications, programs and services is available on the web at [www.api.org](http://www.api.org).